

efi MEZZERA ACTIVA

Open Width Fabric Washing Line for Woven Fabric

High-efficiency
washing line.

Activa washing line

- Under-liquor fluted rolls for improved mass exchange
- Internal countercurrent
- Single and double thread-in
- Customized solutions
- Water-saving
- High washing efficiency
- Working water temperature up to 102 °C
- Runs at low fabric tension
- Wide versatility

The ACTIVA washing box is suited for all applications which utilize the mass exchange by dilution between fabric and liquor as main washing mechanism. The ACTIVA washing box comes from the great Mezzera experience in the field of washing boxes for any type of fabric, from the lighter to the coarser, and any kind of application, for instance washing after dyeing or washing after mercerizing or bleaching after printing.

The main characteristics of the ACTIVA washing box

Liquor flow

The bath flows through a series of labyrinth baffles, so that it goes in countercurrent to the fabric direction. This solution allows maximum washing efficiency with minimal water content. Each washing box can be connected with the previous or following ones with piping and an adequate number of drain and check valves. Adequate bypasses can also be included when a particular section needs to be isolated. The heating system features an indirect steam coil placed inside the vat.

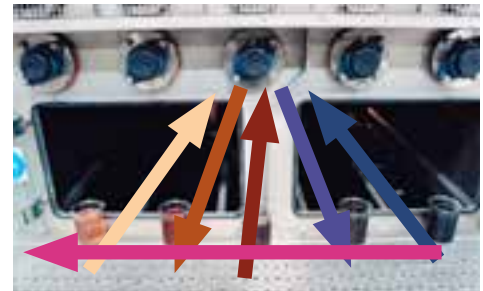

ACTIVA HWT washing efficiency is demonstrated

Fluted rolls

The particular configuration of the under-liquor rolls is another characteristic that makes ACTIVA the most efficient washing box in its category, consumption-wise. The fluted architecture is constructed by a corrugated stainless steel sheet welded to a plain pipe underneath. When the under-liquor rolls move, the fins create a high turbulence increasing the mass exchange between the bath and the fabric. Comparisons between a traditional washing box and the ACTIVA washing box prove that fluted rolls result in a net savings of washing water.

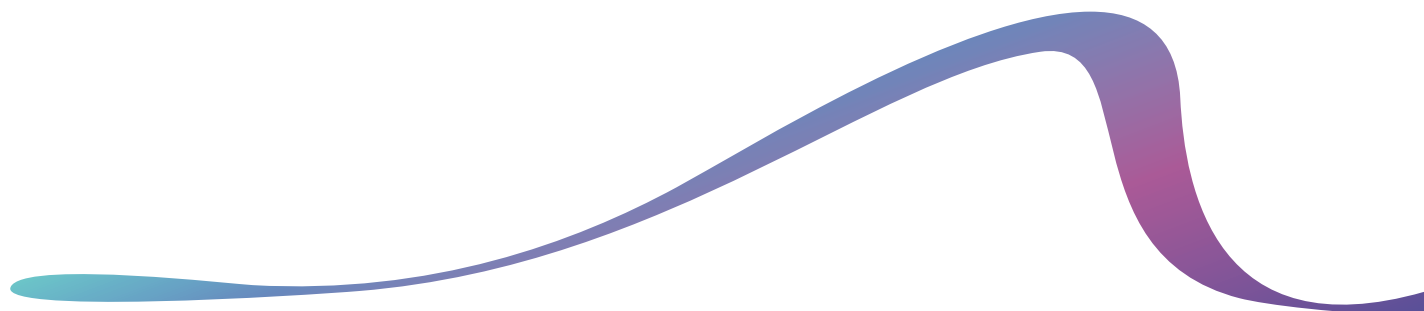

Individual lower-roll driving system

All ACTIVA washing boxes feature lower rolls individually driven by motor-gear groups. The electric motors are powered by an inverter in order to maintain synchronization with the drafting group. A load cell located on the bottom guide roller reads the fabric-tension value; and the relevant signal is then sent to the PLC that controls the inverter. In this way, the tension on the fabric is precisely recorded and controlled in real time. The driving system also allows for the perfect synchronization of all the drafting elements, thereby avoiding potential creases.



Finned cylinders under the liquor



Effect of finned cylinder immersed in the bath



ACTIVA-S double compartment

A unique version for special applications (such as neutralizing/washing) or for customers in need of an additional compartment, the ACTIVA-S washing box comes with two separate compartments, a double water inlet, and two independent thermoregulation systems. The washing box can be operated in single or double mode (with twin thermoregulation, water feeding, and drainage) according to the task.

Single or double thread-in

The ACTIVA washing boxes are available in three versions:

- ACTIVA 724 E with a single thread-in (24 m fabric content)
- ACTIVA 630 E with double thread-in (30 m fabric content)
- ACTIVA 620 E (20 m fabric content)

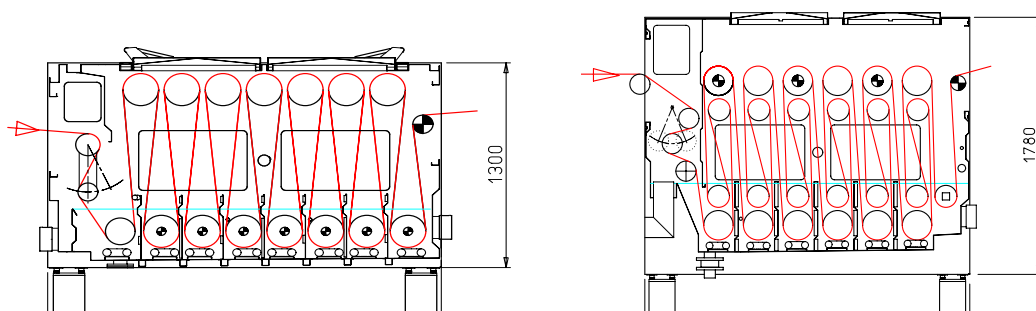

Double individual driving system

In addition to the individual driving-motor gears in the lower row of rollers, Mezzera offers customers the possibility of driving the upper rollers individually as well, making the ACTIVA washing box ideal for more delicate fabrics. The double driving system (with double inverter) is the right solution for the processing of "extra-difficult fabrics" (e.g., those that may develop creases) or fabrics with low tensile strength.



ACTIVA HWT filter view

Intermediate squeezers

In order to further improve washing performance, Mezzera has developed a series of intermediate squeezers as an additional option. The squeezers are driven by a pneumatic system, enabling them to squeeze fabric up to about 500 kgf. Thus the liquor entrained with the fabric is squeezed out and conveyed to the upstream compartment, allowing the cleaner liquor in the next compartment to wash the fabric more efficiently through increased mass exchange.



ACTIVA HWT

The ACTIVA HWT unit is a washing box featuring finned rollers and superheated water spray. It has been purposely designed for desizing, scouring, and washing after the printing or dyeing processes have been completed. The tank's circulation is initiated by a pump that feeds the liquor through a filter into a heat exchanger—where the set temperature is reached—and then into spray pipes where the liquor treats fabric mixed with steam. The top and bottom rollers are driven by an elastic belt and a load-cell synchronized motor.



ACTIVA HWT Water force concept

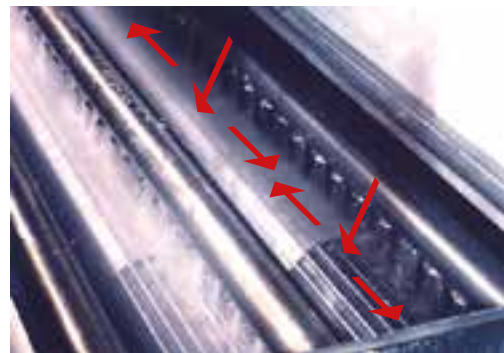

ACTIVA HWT water force

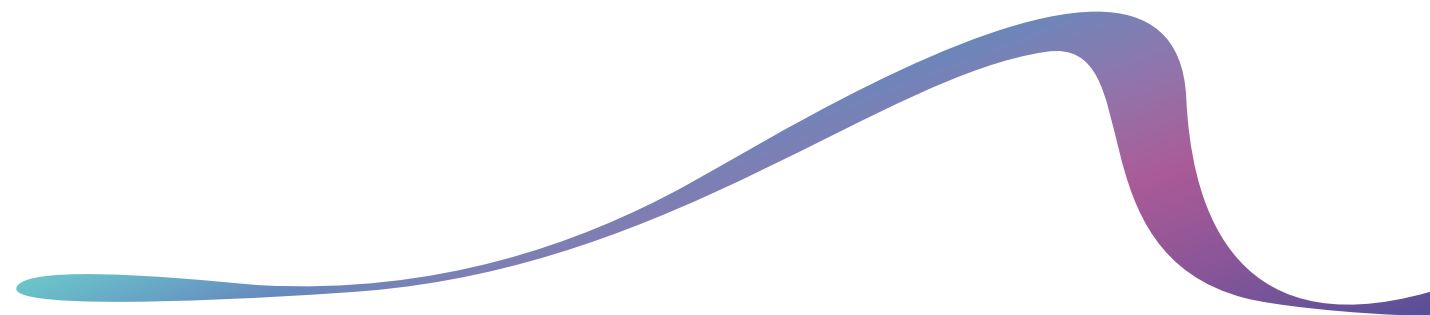

Guide rollers

The large-diameter lower finned rollers are individually driven by motor gears. The large-diameter top finned rollers are mounted onto supports with bearings. Double thread-in boxes (ACTIVA 630 E) boast finned inner-guide rollers as well.

Spray pipes and self-cleaning filters

Each top roller has a pipe above it with calibrated spray nozzles to provide a uniform spray of washing water. The self-cleaning filters have a high water-flow ratio so that the spray-pipe intake can be filtered to remove small protruding fibers, residue, and other impurities carried by the fabric.

Scouring and bleaching

The ACTIVA HWT's characteristics perfectly suit processes where a deep mechanical and thermal action are required. The ideal position of the ACTIVA HWT washing box is at the beginning of the line, where it can remove residues after the desizing/CPB and give the right hydrophilicity to the fabric before chemical impregnation and steaming. A second ACTIVA HWT washing box is normally positioned after the steamer, guaranteeing excellent washing action.

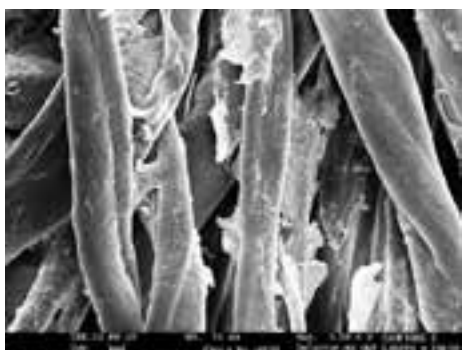

Cotton fabric bearing starch residues after a traditional washing

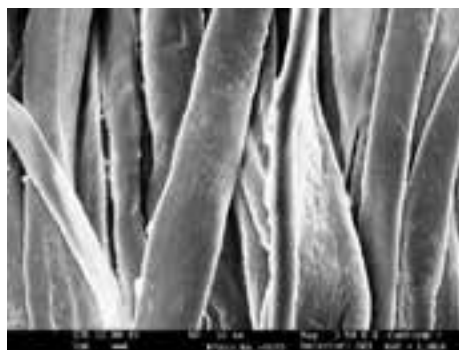

Cotton fabric washed with ACTIVA HWT at the same operation conditions

Desizing of cotton and scouring of synthetics

The ACTIVA HWT's thermal action can restart the reaction of the desizing chemicals as well as properly wash the fabrics after the CPB operation.

For synthetic-fiber fabrics, the combination of the thermal and mechanic actions provides for the perfect removal of the spinning oils. An adequate number of high-efficiency ACTIVA rinsing boxes is also required, in order to wash out the dissolved substances.

Heat exchanger

The heat exchanger is located on the delivery side of the pump and superheats the liquor under pressure to the temperature set on the thermo-regulator. Thanks to the special manufacturing technique, the liquor can reach 105 °C.

The control system is based on a state-of-the-art PLC installed in a watertight cabinet. This unit is controlled from an ergonomic control panel that allows users to save, control, and recall treatment parameters.

Washing after printing or dyeing

The ideal position of the ACTIVA HWT washing box is in the high-temperature washing zone, where the ACTIVA HWT is utilized to the best of its capabilities, providing a faster wash process than normal washing boxes.

One steamer scouring and bleaching

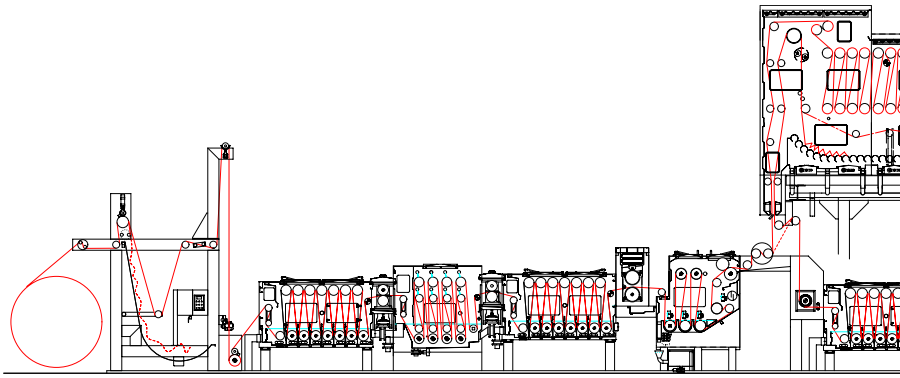

Washing line

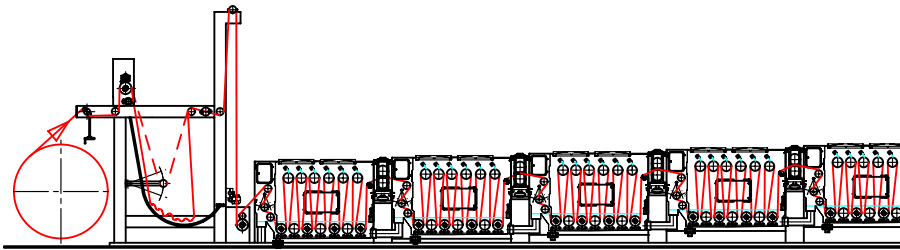

Chain-less mercerizing

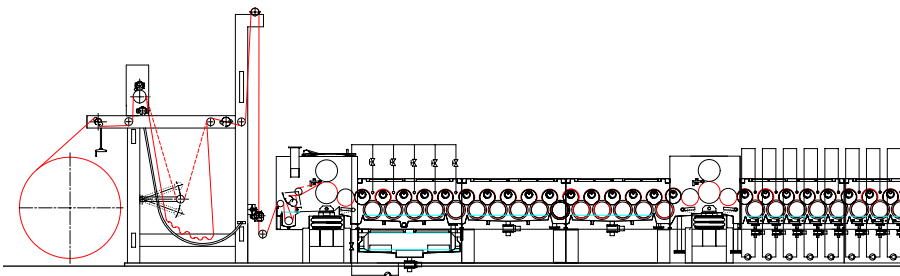

TECHNICAL DATA	ACTIVA 724 E	ACTIVA 630 E
Roller width (mm)	1800÷3600	1800÷3600
Fabric content (m)	20	30
Liquor volume (l/m)*	1050	800
Installed power (kW)	5	5
Double compartment	ON VERSION S	ON VERSION S
Intermediate squeezer	OPTIONAL	OPTIONAL

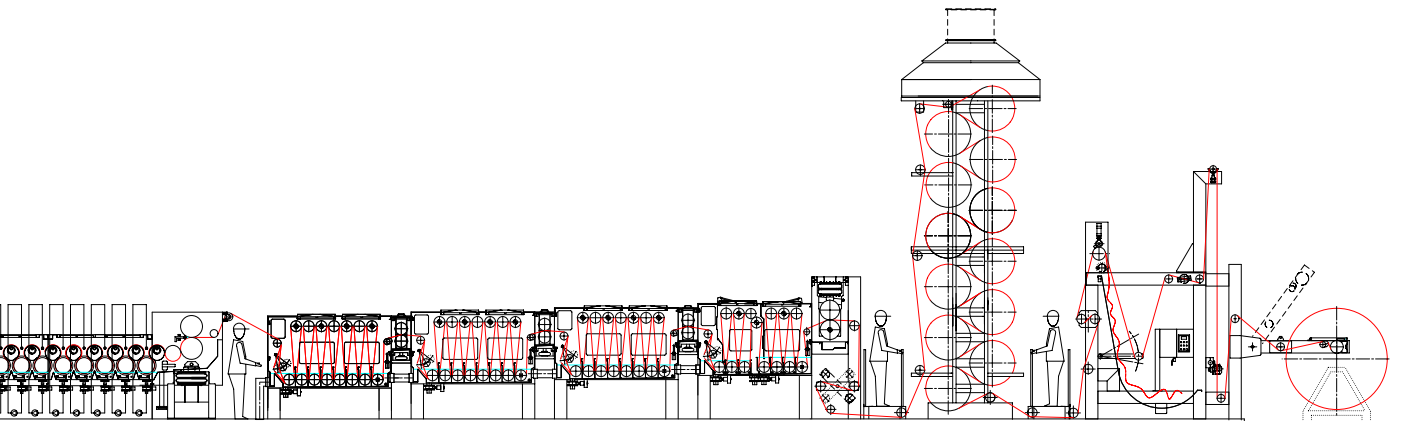
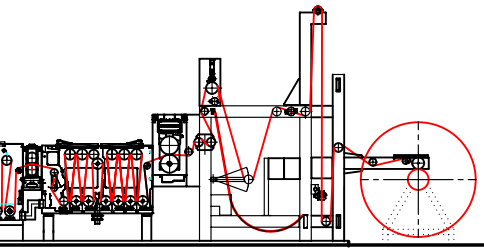
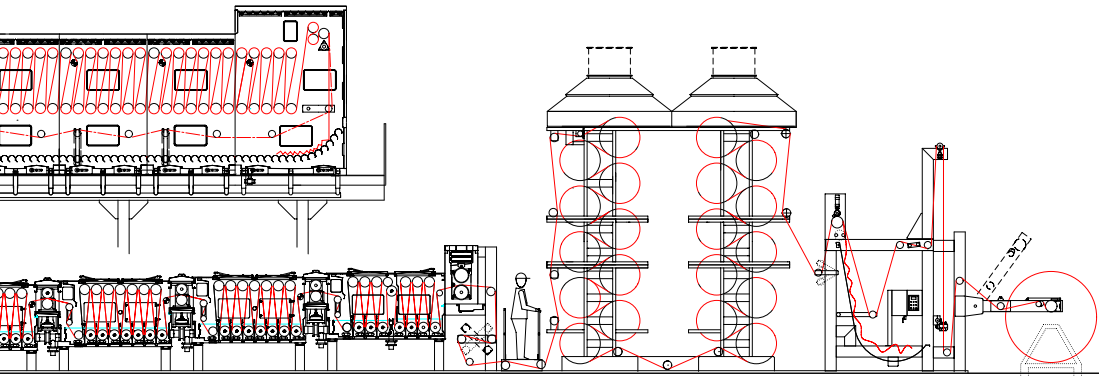

EFI fuels success.

We develop breakthrough technologies for the manufacturing of signage, packaging, textiles, ceramic tiles, and personalised documents, with a wide range of printers, inks, digital front ends, and a comprehensive business and production workflow suite that transforms and streamlines the entire production process, increasing your competitiveness and boosting productivity. Visit www.efi.com or call +39 035 3844511 for more information.



Nothing herein should be construed as a warranty in addition to the express warranty statement provided with EFI products and services.

The APPS logo, AutoCal, Auto-Count, Balance, Best, the Best logo, BESTColor, BioVu, BioWare, ColorPASS, Colorproof, ColorWise, Command WorkStation, CopyNet, Cretachrom, Cretaprint, the Cretaprint logo, Cretaprinter, Cretaroller, DockNet, Digital StoreFront, DirectSmile, DocBuilder, DocBuilder Pro, DocStream, DSFdesign Studio, Dynamic Wedge, EDOX, EFI, the EFI logo, Electronics For Imaging, Entrac, EPCount, EPPhoto, EPRegister, EPStatus, Estimate, ExpressPay, Fabrivu, Fast-4, Fiery, the Fiery logo, Fiery Driven, the Fiery Driven logo, Fiery JobFlow, Fiery JobMaster, Fiery Link, Fiery Prints, the Fiery Prints logo, Fiery Spark, FreeForm, Hagen, Inkintensity, Inkware, Jetrion, the Jetrion logo, LapNet, Logic, MiniNet, Monarch, MicroPress, OneFlow, Pace, PhotoXposure, Printcafe, PressVu, PrinterSite, PrintFlow, PrintMe, the PrintMe logo, PrintSmith, PrintSmith Site, PrintStream, Print to Win, Prograph, PSI, PSI Flexo, Radius, Rastek, the Rastek logo, Remoteproof, RIPChips, RIP-While-Print, Screenproof, SendMe, Sincolor, Splash, Spot-On, TrackNet, UltraPress, UltraTex, UltraVu, UV Series 50, VisualCal, VUTEK, the VUTEK logo, and WebTools are trademarks of Electronics For Imaging, Inc. and/or its wholly owned subsidiaries in the U.S. and/or certain other countries.